

Manufacturing Solutions

Robert 'Buzz' Kross
Senior Vice President, Manufacturing

Drawings

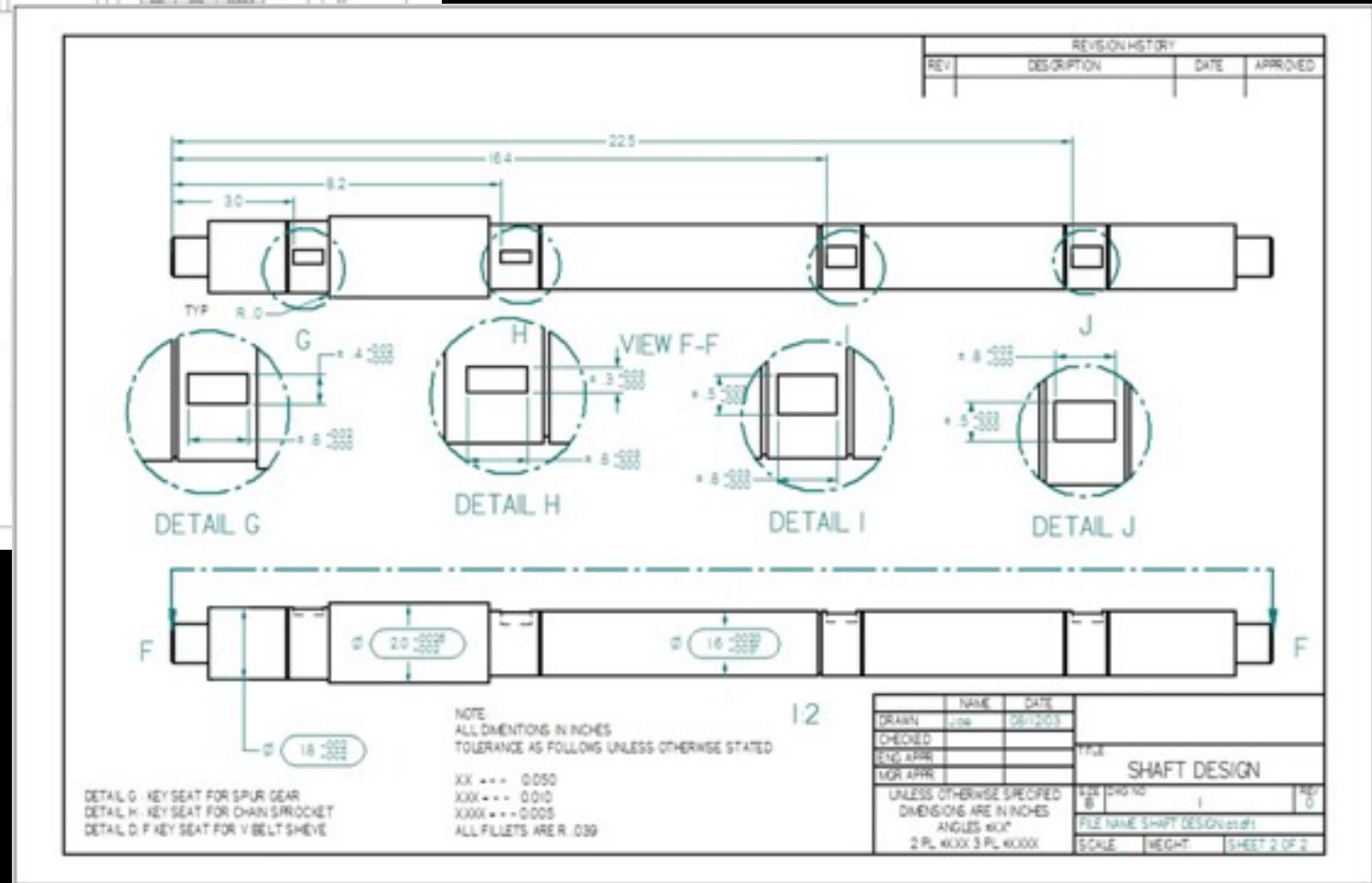
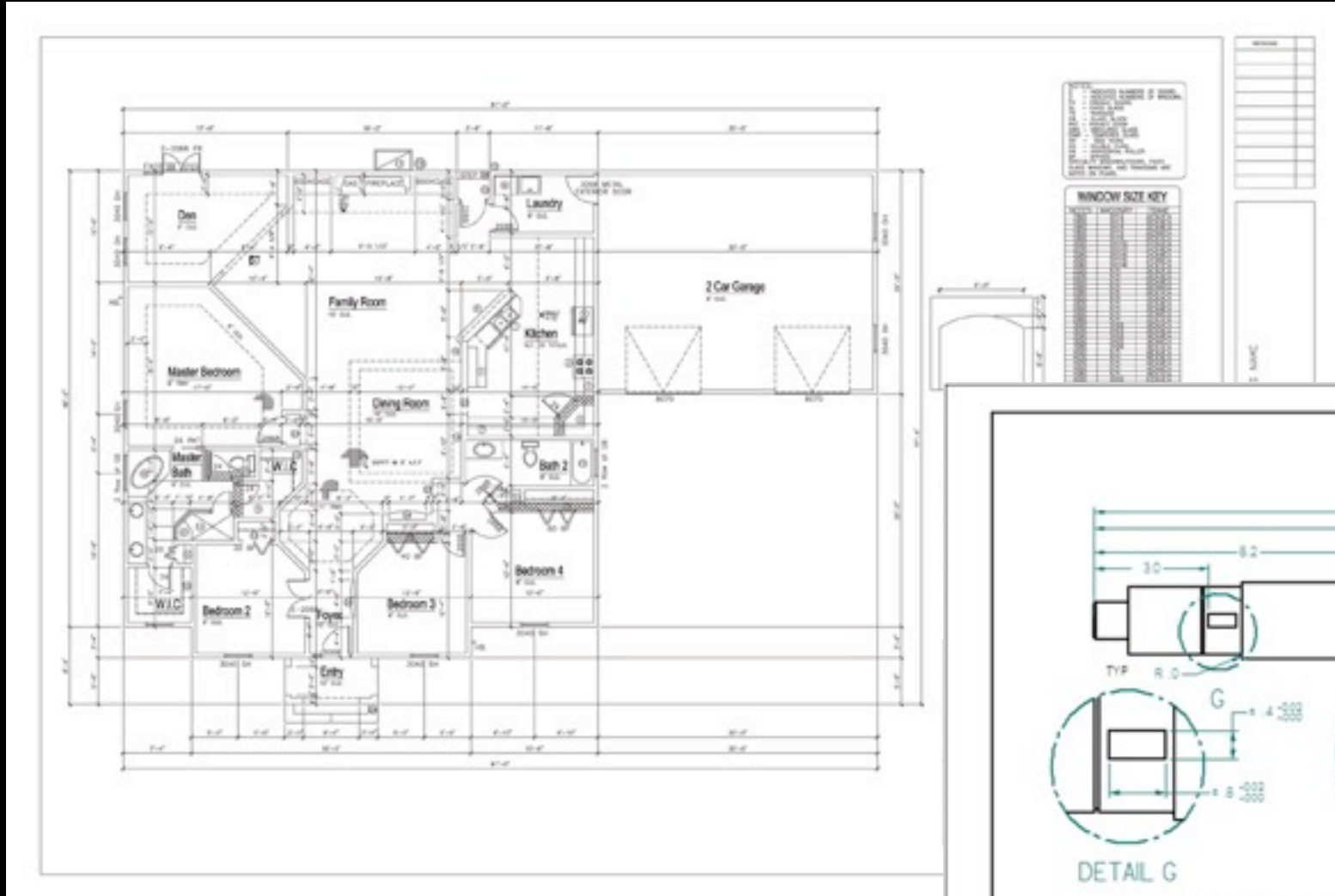

3D Models

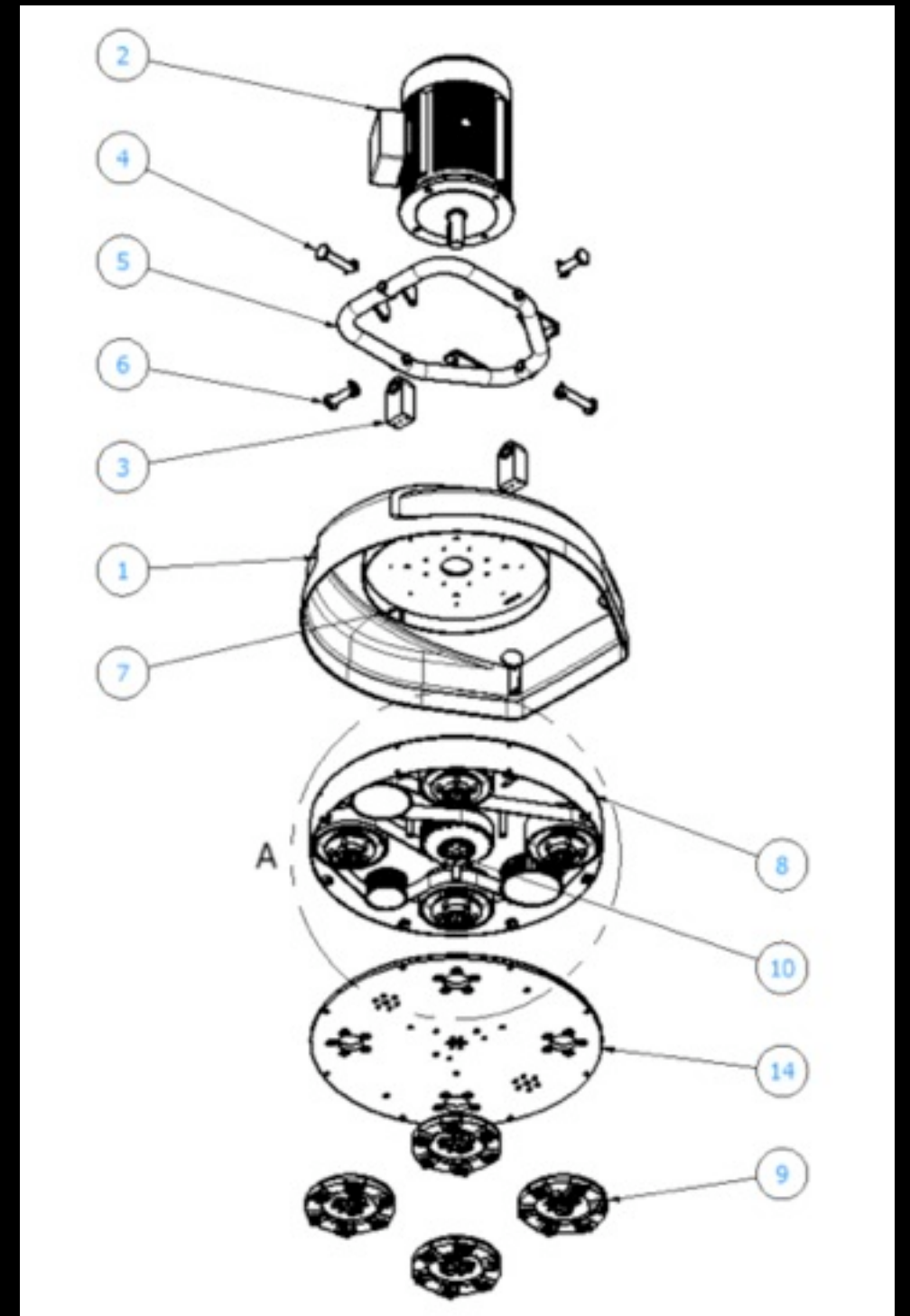

Complete Systems

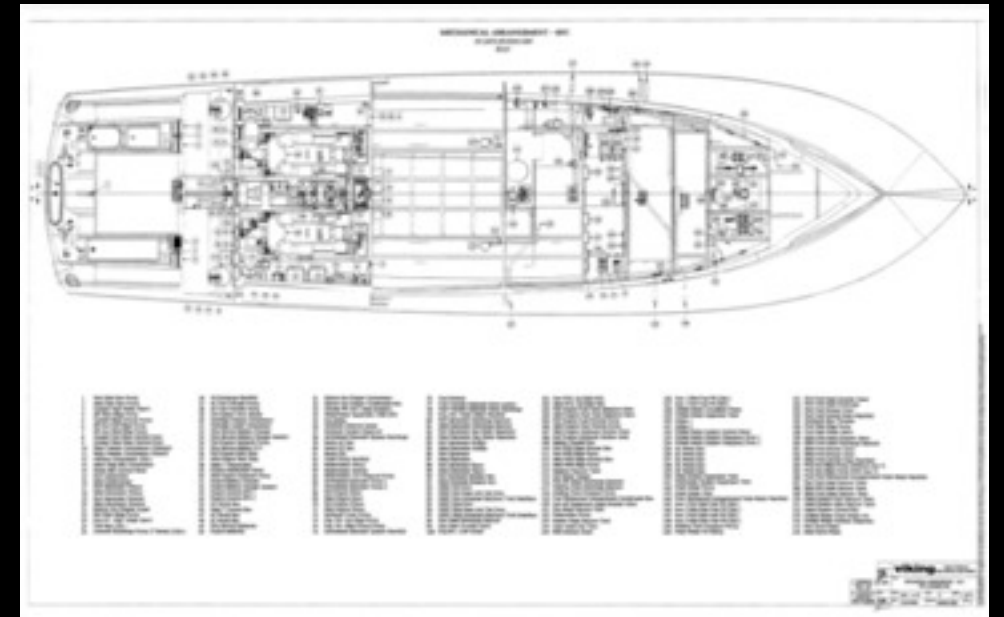
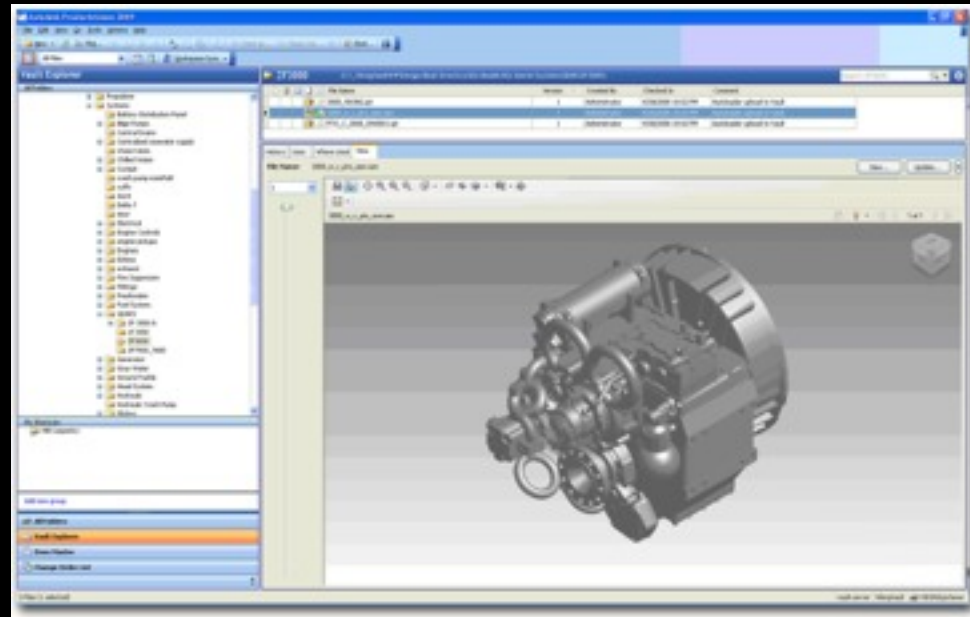
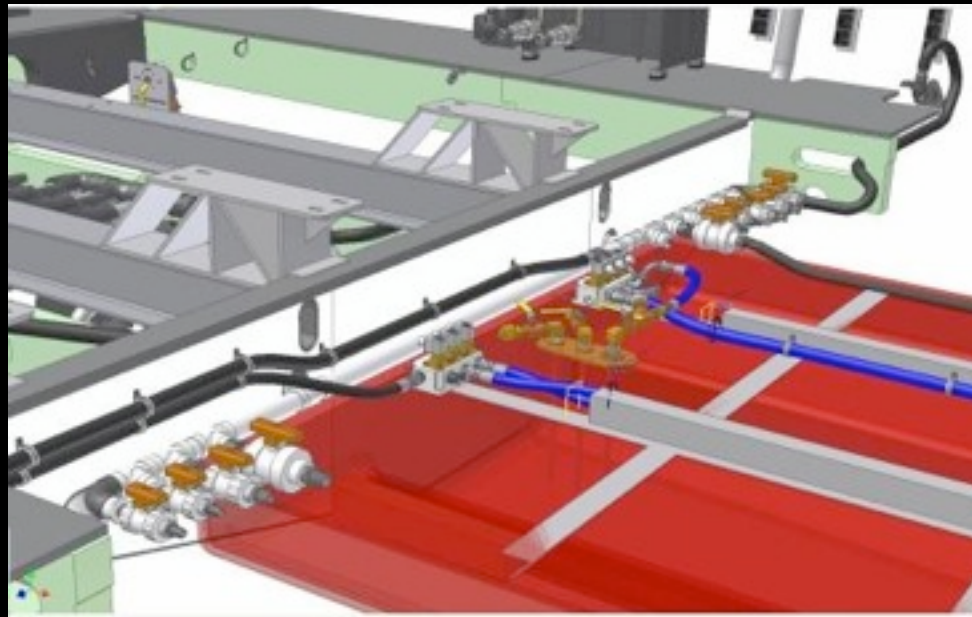
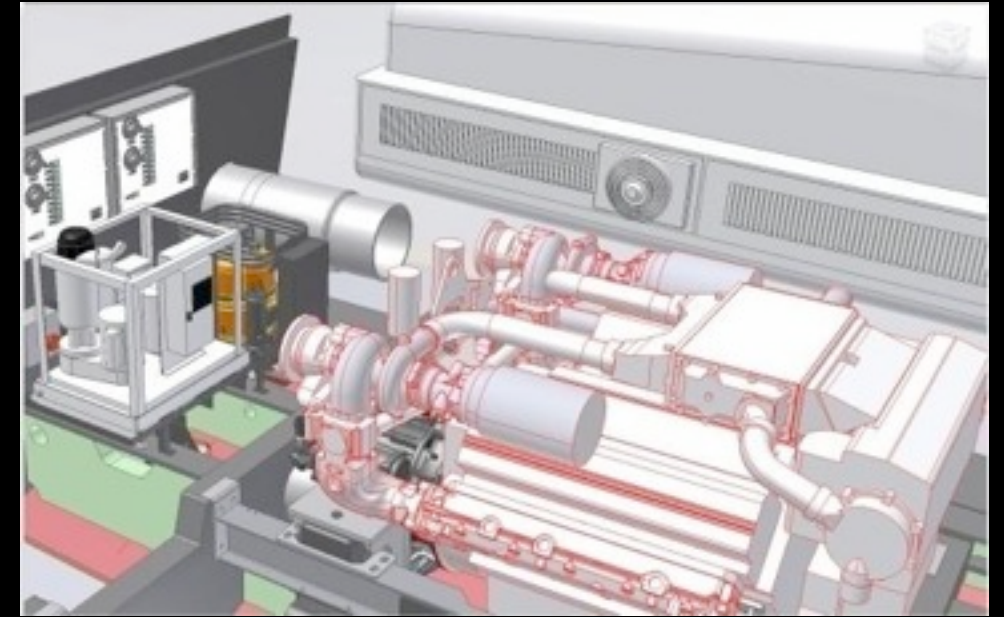
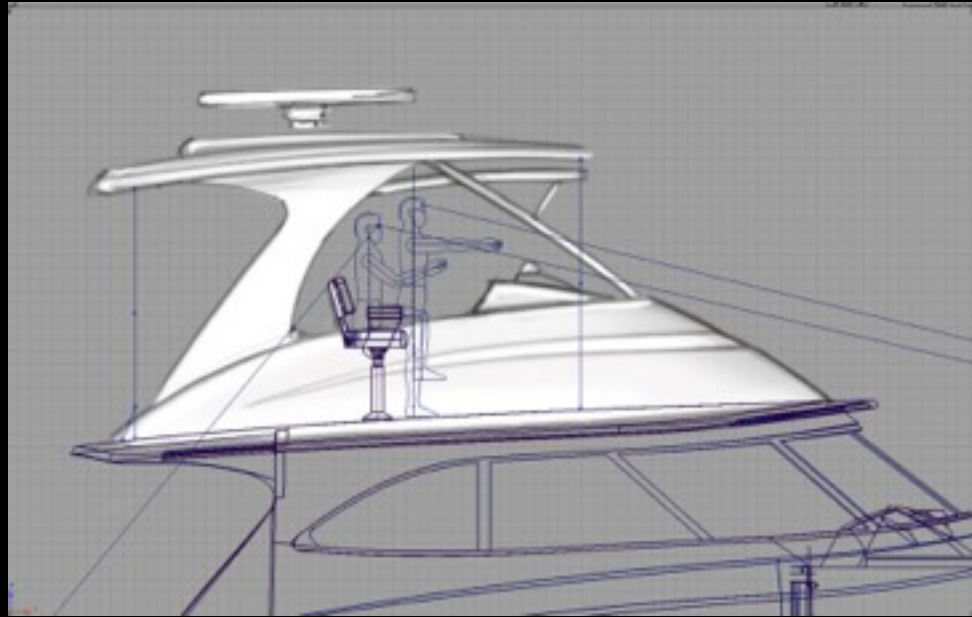



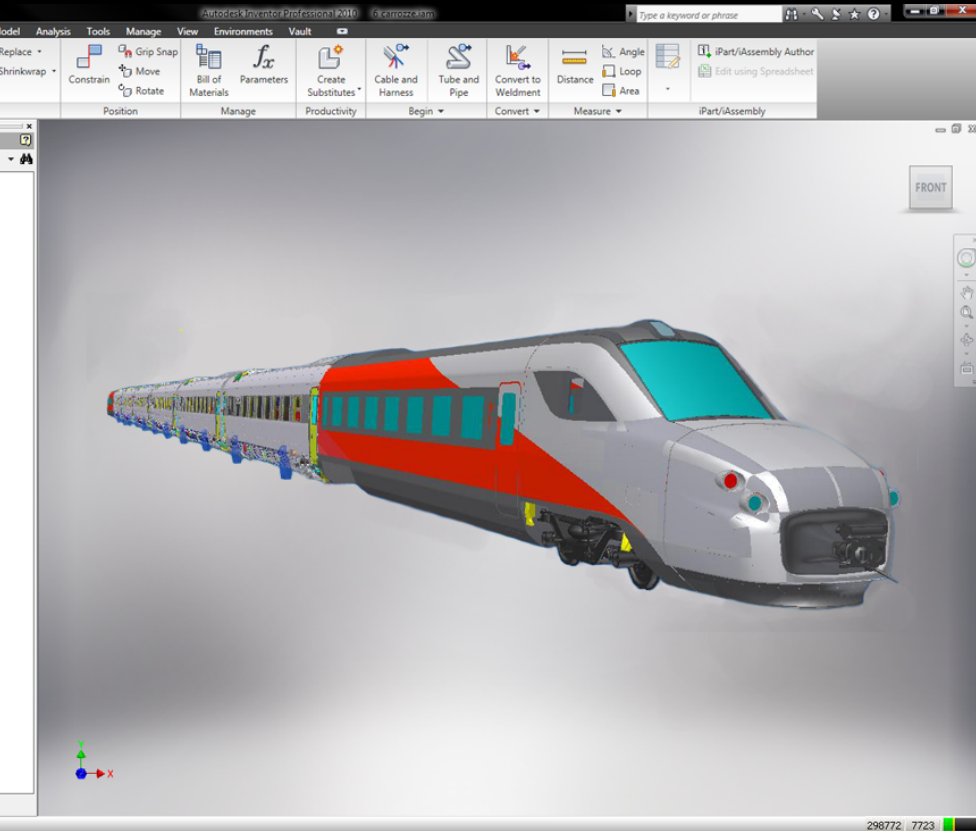

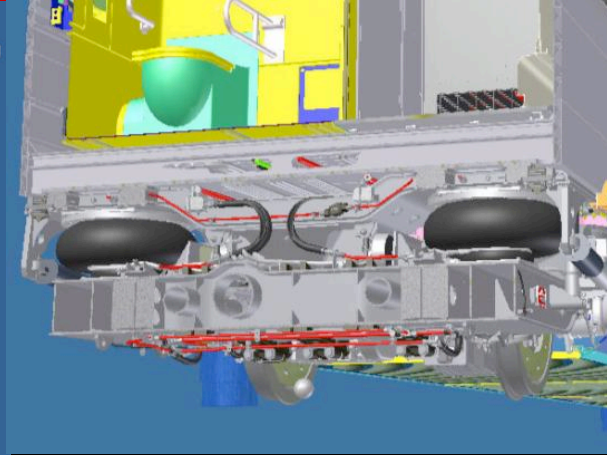
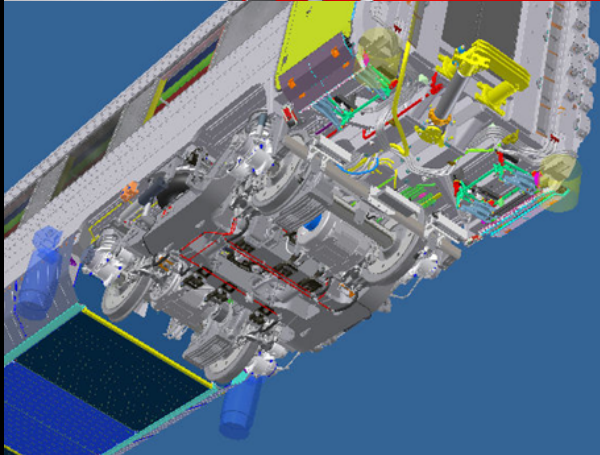
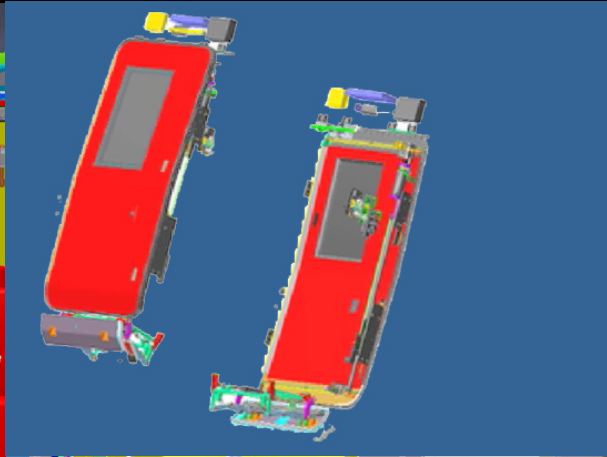



Unprecedented Change



Great Products Sell

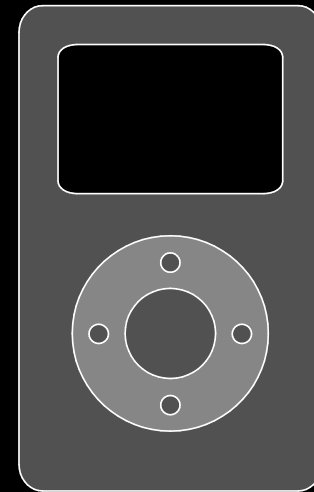
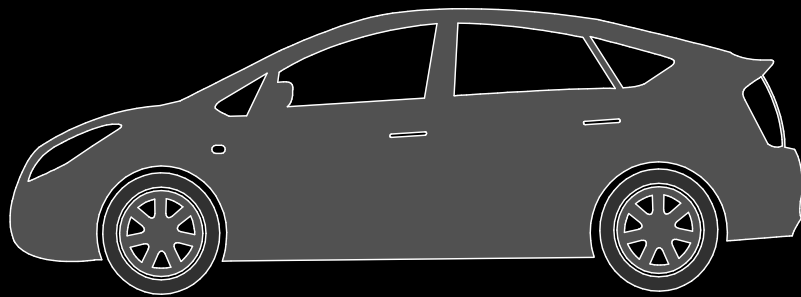

Broad Solution

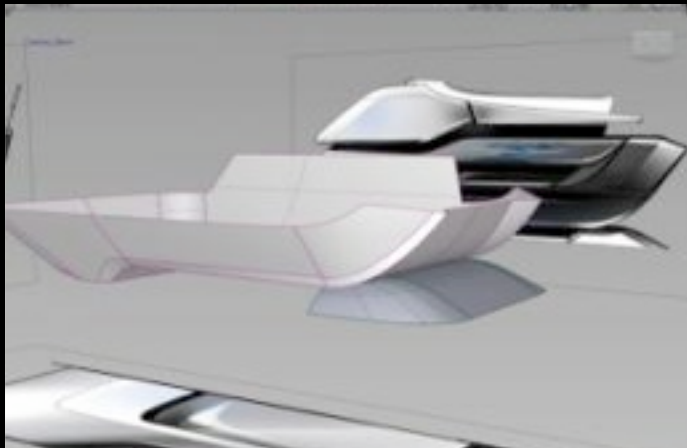

Conceptual Design



Visualization

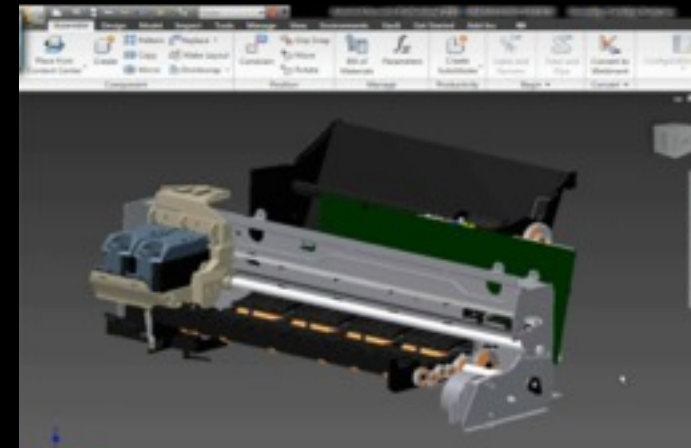

Mechanical



Routed Systems

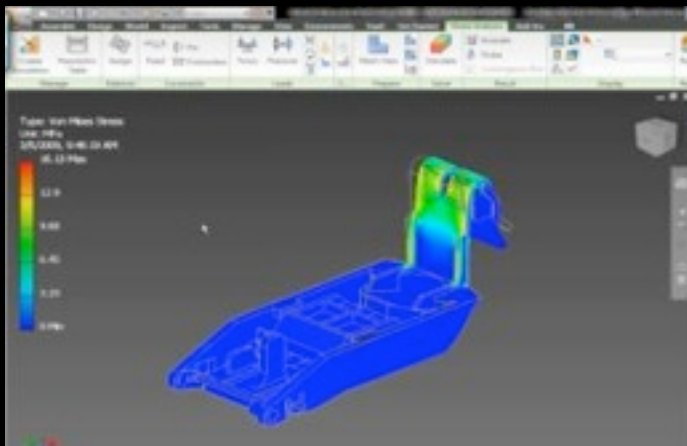

Simulation

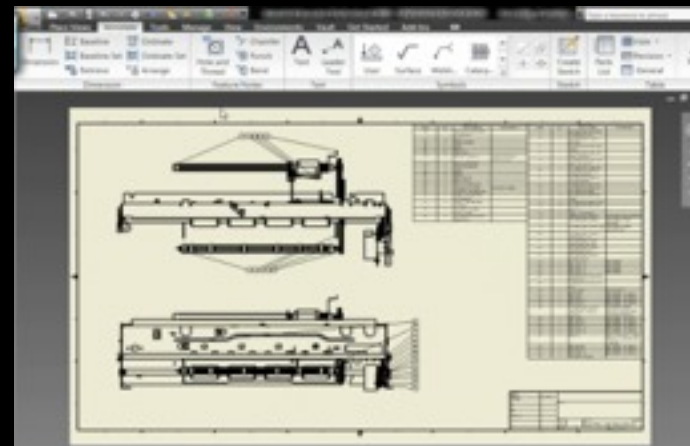

Documentation

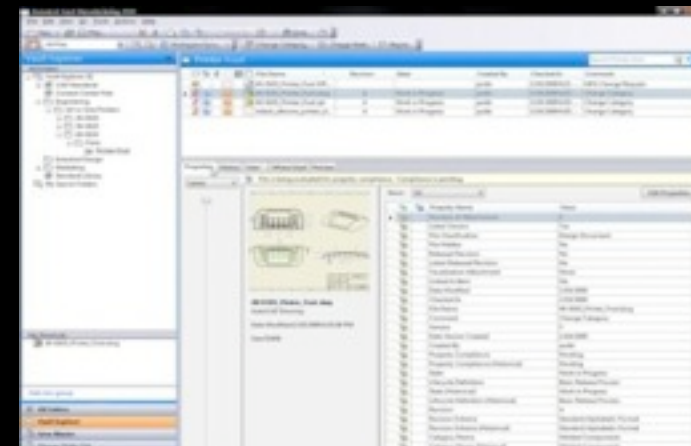

Data Management

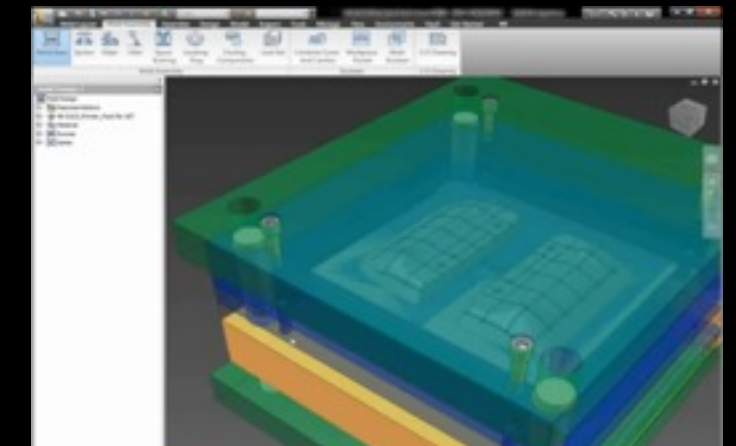

Manufacturing

In-Product Simulation

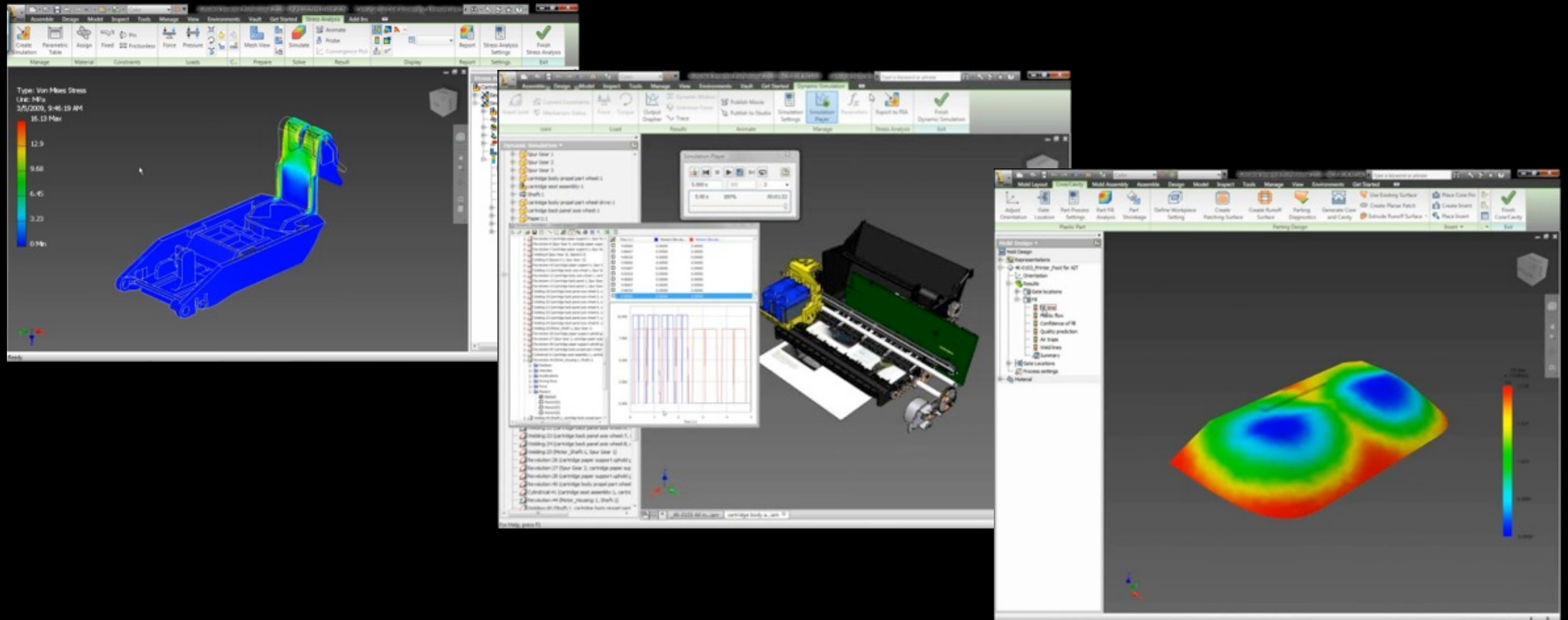

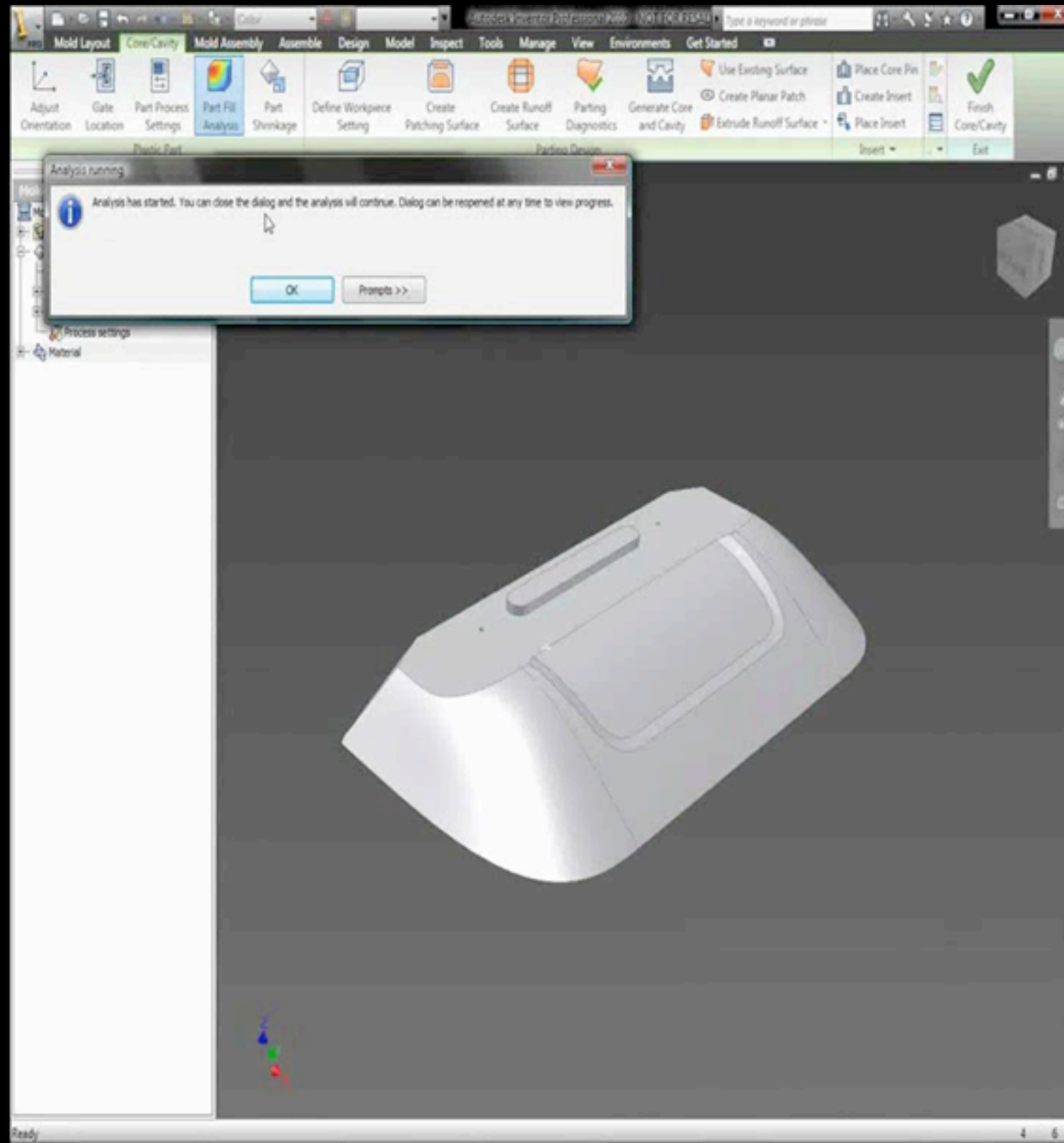

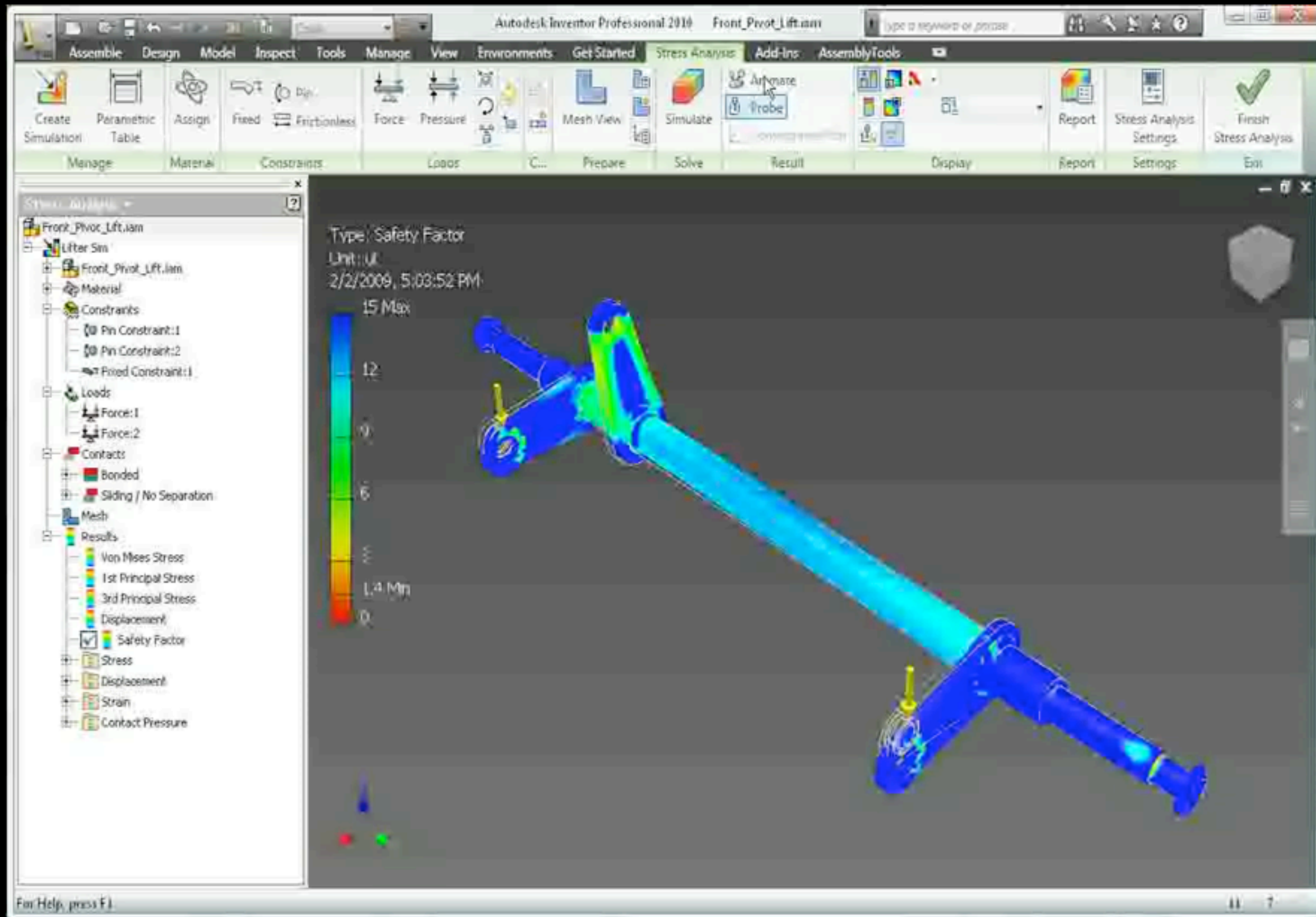

Advanced Simulation

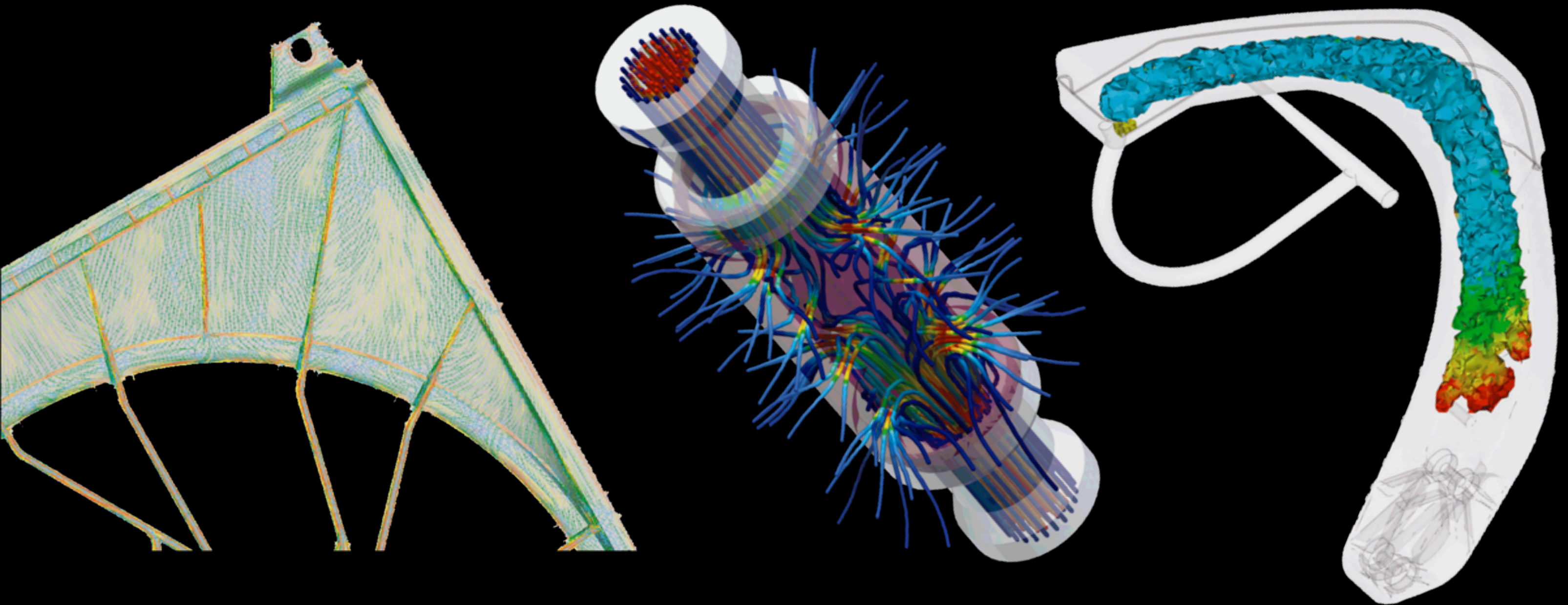

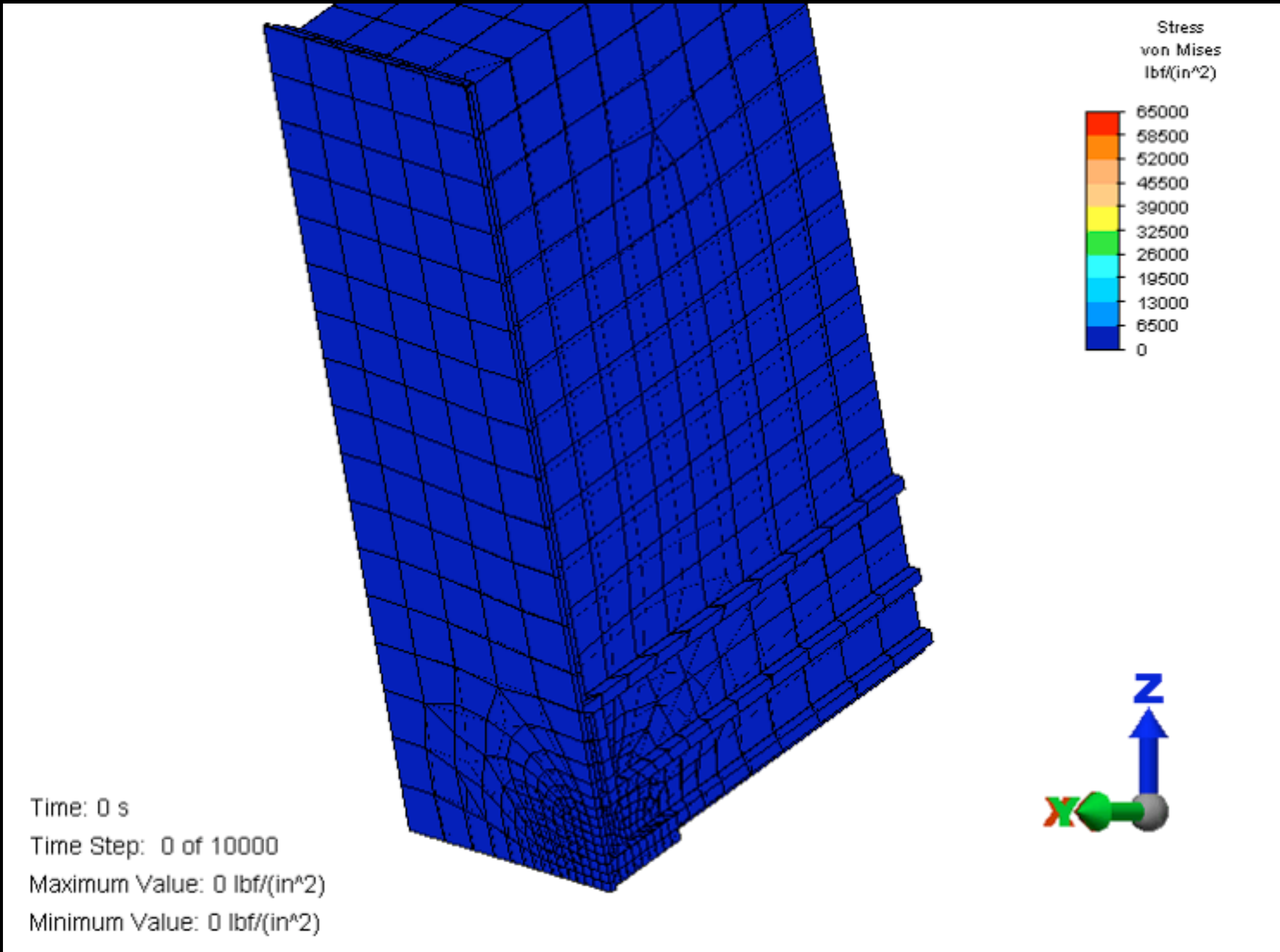

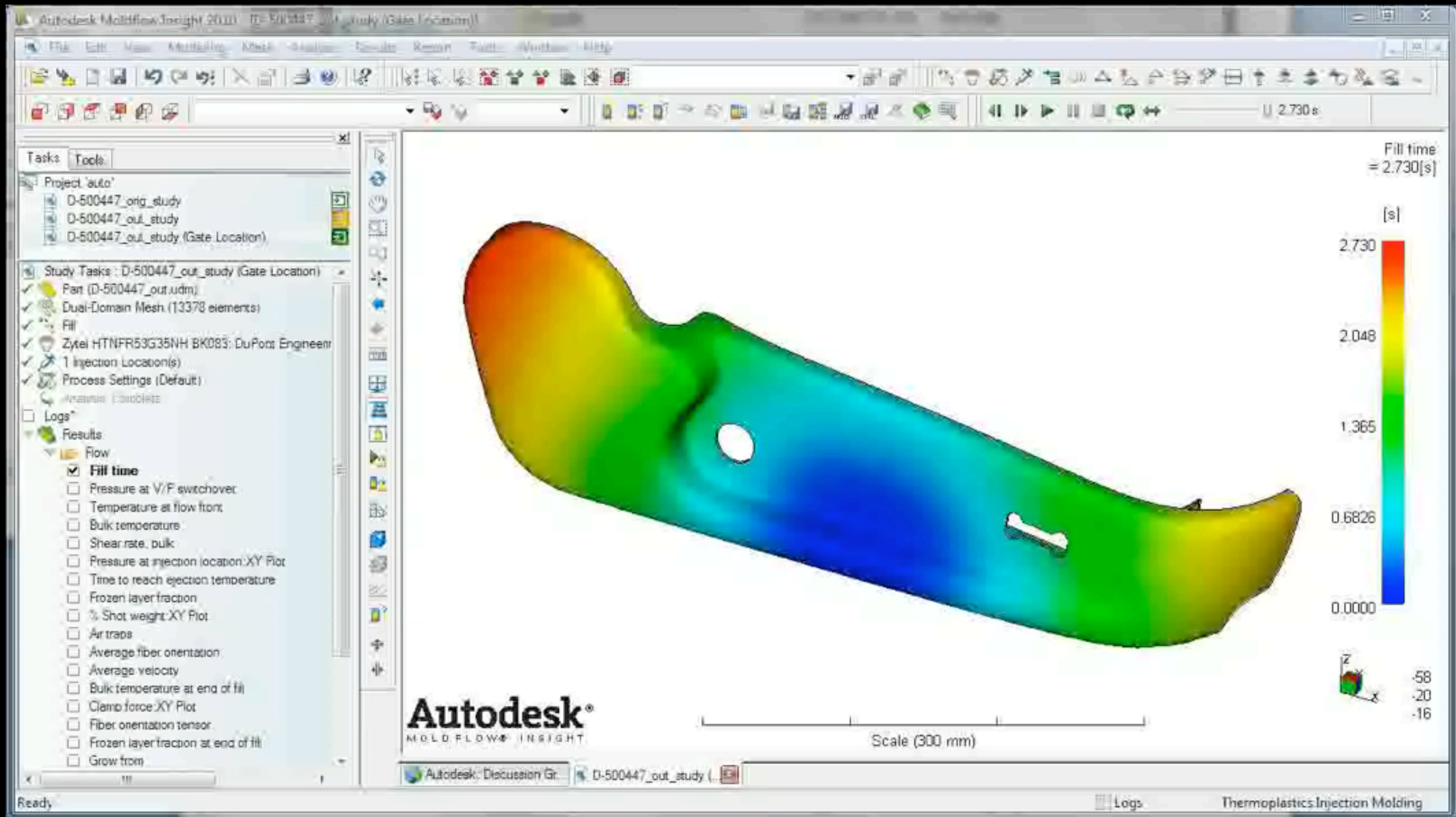

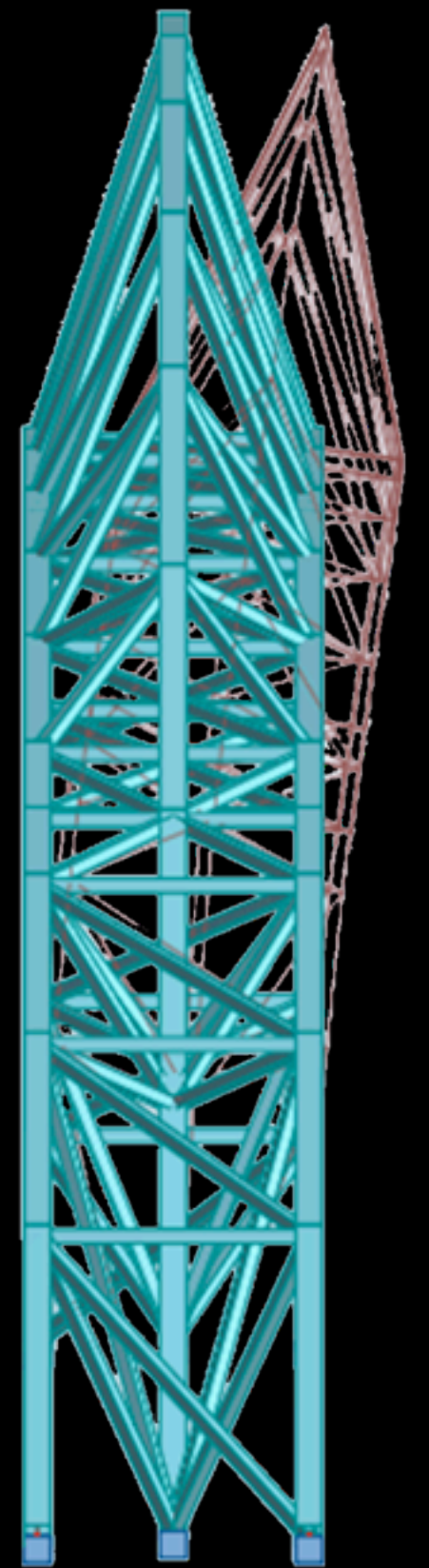
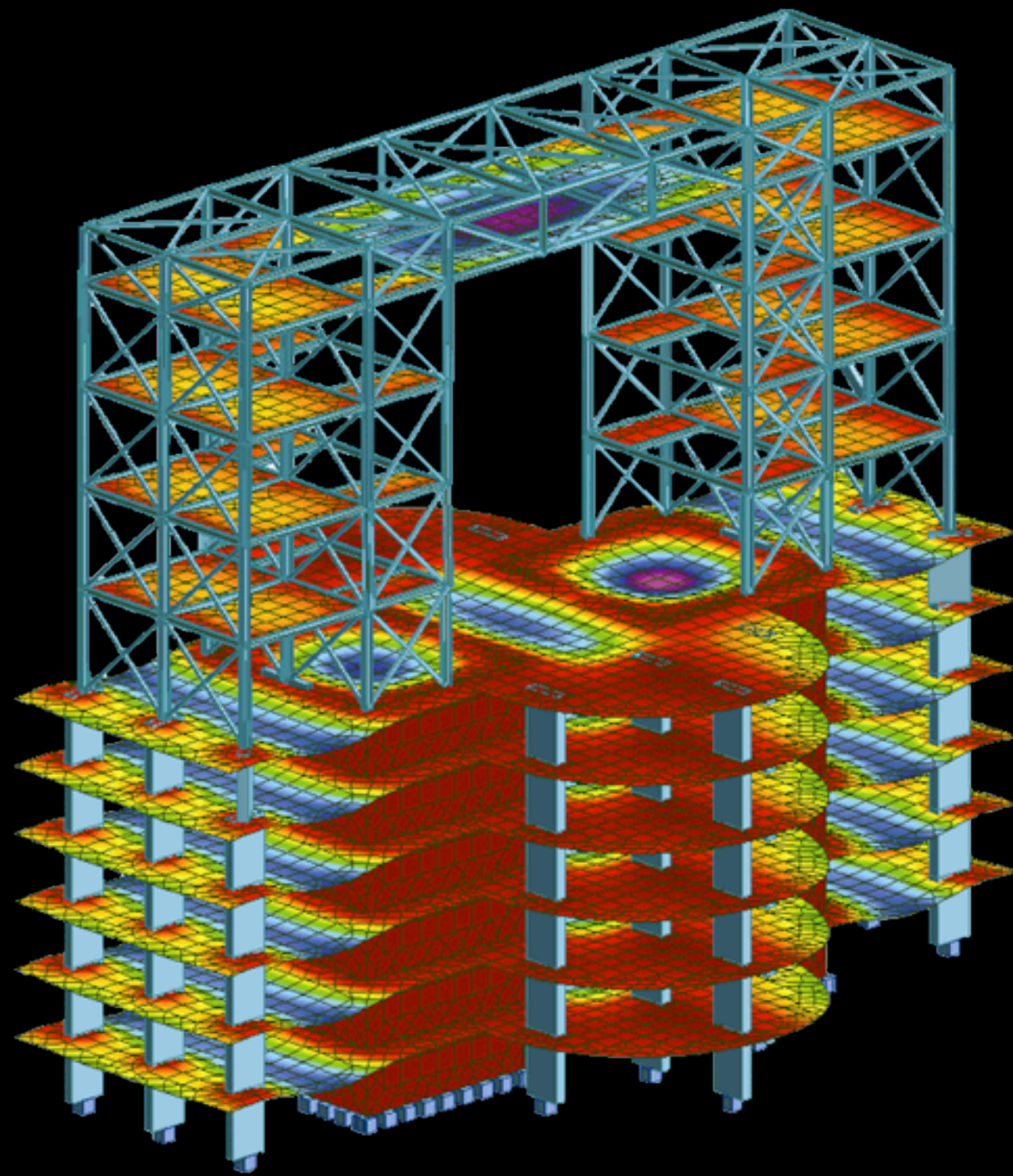
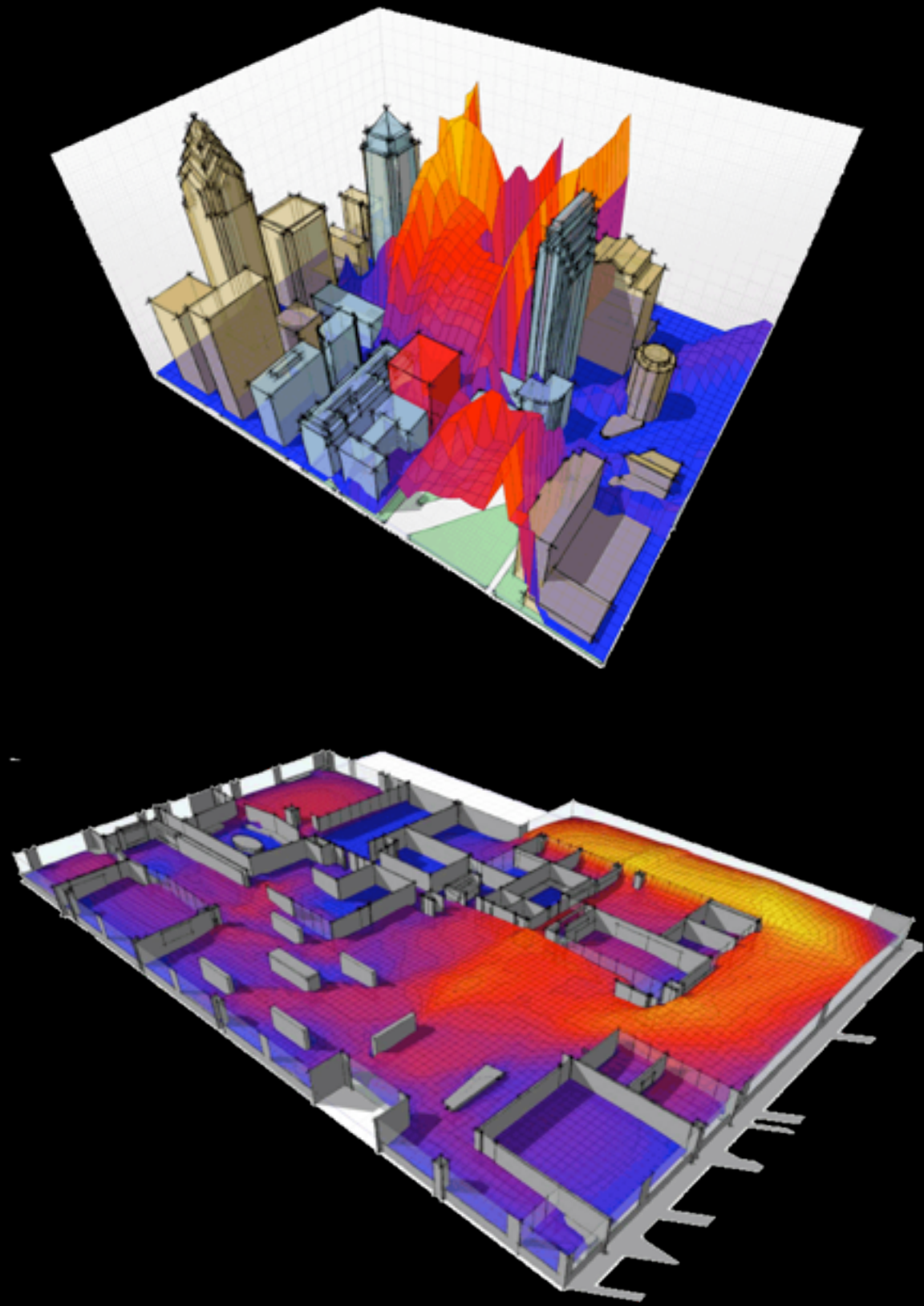

Design Visualize Simulate

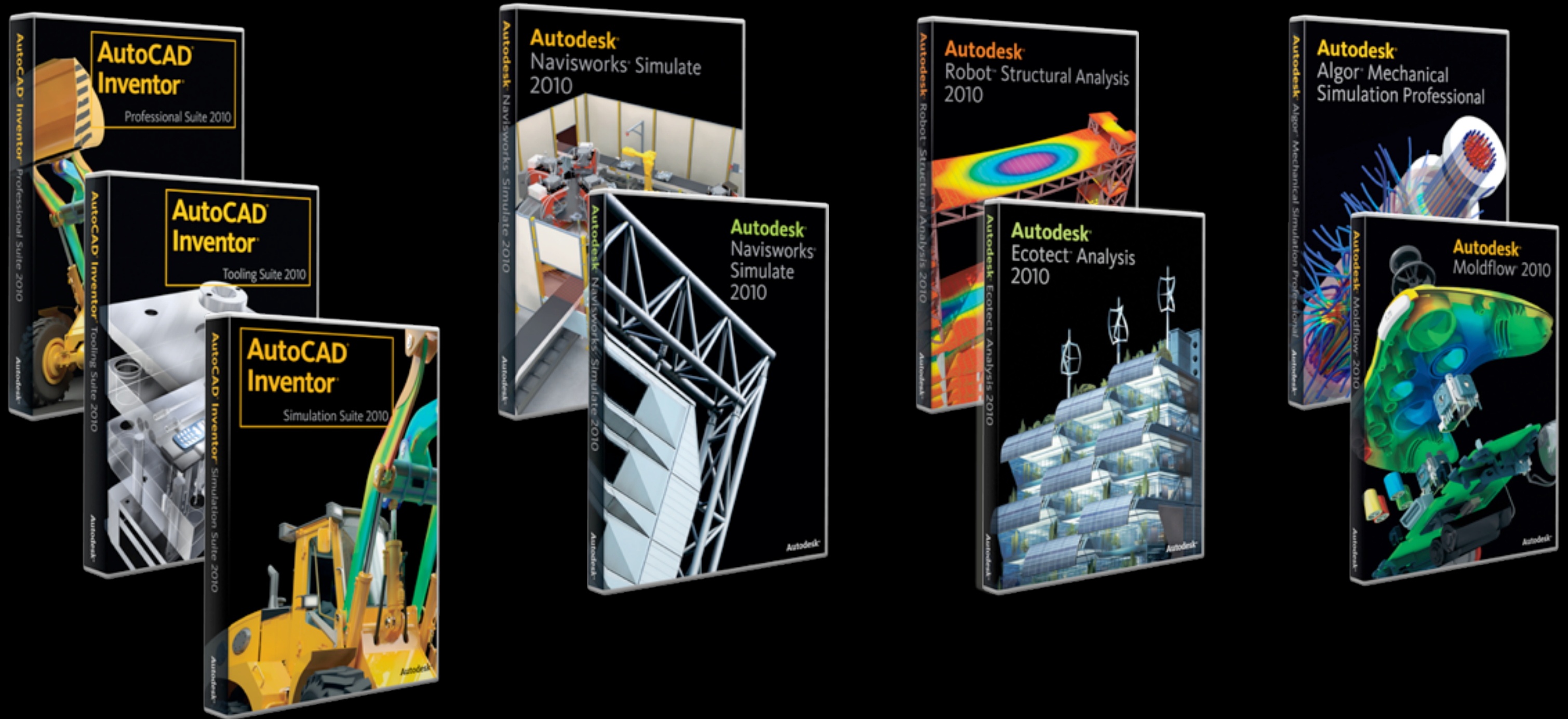

Business Opportunities

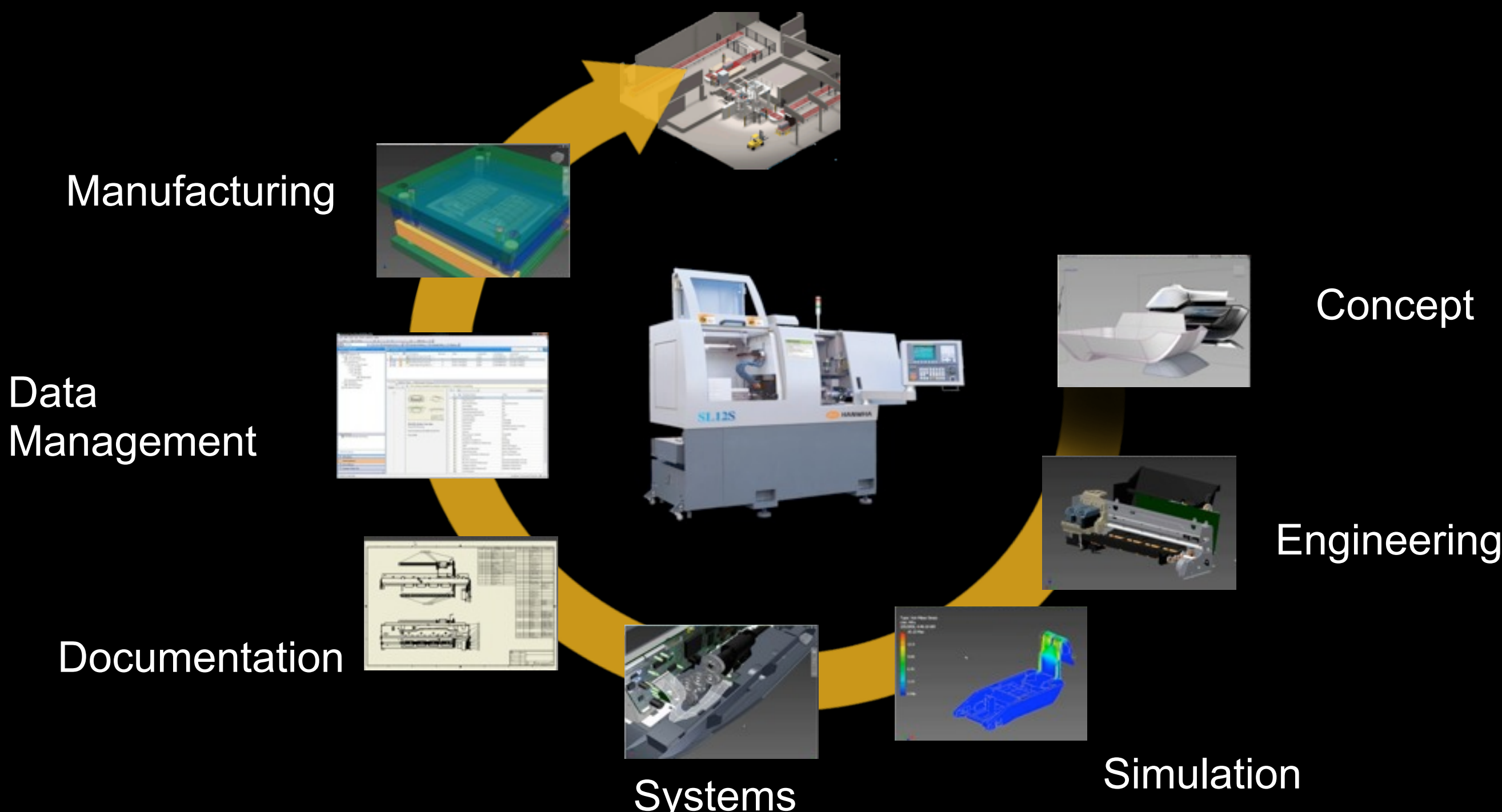

Autodesk®